

HELIUM-CADMIUM LASER INSTRUCTION MANUAL

FOR

LASER HEAD			POWER SUPPLY
IK4301R-D	IK3101R-D	IK5351R-D	KR1801C
IK4401R-D	IK3152R-D	IK5352R-D	
IK4601R-E	IK3202R-D	IK5451R-E	
IK4101R-F	IK3151R-E	IK5452R-E	
IK4121R-G	IK3252R-E	IK5551R-F	
IK4131I-G	IK3201R-F	IK5552R-F	
IK4171I-G	IK3401R-F	IK5651R-G	
	IK3452R-F	IK5652R-G	
	IK3301R-G	IK5751I-G	
	IK3501R-G	IK5752I-G	
	IK3552R-G		
	IK3802R-G		
	IK3102R-G		

*Please read this instruction manual carefully and thoroughly
before installing or operating your laser.*

 **KIMMON KOHA CO., LTD.**

1-53-2 ITABASHI, ITABASHI-KU, TOKYO, 173-0004 JAPAN
PHONE +81-3-5248-4820 FAX +81-3-5248-0021

September, 2013

Table of Contents

1. Introduction	1
1-1 Laser Safety	1
1-2 Labelling	2
1-3 Location of Labels and Safety Parts	3
1-3-1 Laser Head (IK3***,IK4****)	3
1-3-2 Laser Head (IK5***)	4
1-3-3 Power Supply (KR1801C)	5
2. Laser Specifications	7
2-1 Specifications	7
2-2 Dimensions	11
2-2-1 Laser Head (IK3***,IK4***)	11
2-2-2 Laser Head (IK5***)	12
2-2-3 Wavelength Selector (IK5***)	13
2-2-4 Laser Power Supply (KR1801C)	14
3. Laser Block Diagram	16
4. Safety Recommendations & Safety Hazard Warning	17
4-1 General Instruction	17
4-2 High Voltage and Temperature Hazard	17
4-3 Handling and Installation	17
4-4 Abnormal Conditions	17
5. Operating Instruction	18
5-1 Inspection Requirement upon Receipt	18
5-2 Packing Contents	18
5-3 Installation	18
5-4 Cables	18
5-5 Operation	19
5-5-1 Actuation Sequence	19
5-5-2 Start up	19
5-5-3 Shutdown	19
5-6 Status Indicators	20
6. Trouble Shooting	21
6-1 Diagnostic Flow Chart (No Power Status)	21
6-2 Diagnostic Flow Chart (Emission Indicator "OFF" Status)	21
6-3 Diagnostic Flow Chart (Emission Indicator "ON" Status)	22
6-4 Diagnostic Flow Chart (Decreased Laser Output Power)	23
6-5 Diagnostic Flow Chart (Increased Noise Level)	24
6-6 Diagnostic Flow Chart (Laser Power Fluctuates)	25
6-7 Diagnostic Flow Chart (Other Status)	25
7. Maintenance and Adjustment	26
7-1 Mirror Alignment	26
7-2 Tube Voltage	27
7-3 Tube Current	28
7-4 Helium Gas Pressure Adjustment	29
7-5 Laser System Storage Period	30
8. Laser System Disposal	30
9. Package for Tube Refurbishing and Repairing	30
10. Where to Contact Us	30
Attachment---About requirements of Chinese RoHS	

1. Introduction

Thank you very much for your purchase of KIMMON IK-Series compact Helium-Cadmium laser system. For your safety and long-lasting performance of your laser system, please follow instructions contained in this manual when installing or operating your laser system.

1-1 Laser Safety

This laser system is classified as "Class 3B" laser by the international standard, IEC60825-1: Safety of laser products, and as "Class III b" laser by the Center for Devices and Radiological Health (CDRH) of US Food and Drug Administration (FDA). Class 3B/III b levels of lasers radiation are considered to be an acute hazard to the skin and eyes from direct radiation.

- a) Do not look directly into the laser beam.
- b) Always use protective glasses (for 325nm or 442nm) when operating your laser.
- c) Set up a restricted access area for laser operation.
- d) Post a warning sign near the laser area.
- e) Do not open the laser head cover or power supply cover.
- f) Do not turn the laser head upside down.

Warning

Do not remodel or dismantle our products by third party.
We can not guarantee any problem by these acts.

Caution

Use of controls or adjustments or performance of procedures other than specified herein may result in hazardous radiation exposure.

Caution

Use only the power supply specified in the label on the laser head with required input voltage. Failure to operate with proper power supply causes permanent damage to the head.

1-2 Labelling



LASER PRODUCTS LABEL



LASER RADIATION WARNING LABEL



LASER APERTURE LABEL

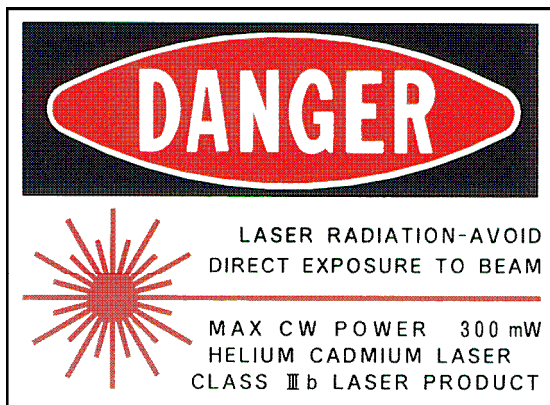

WARNING LOGOTYPE



CERTIFICATION AND
 IDENTIFICATION LABEL

1-3 Location of Labels and Safety Parts
1-3-1 Laser Head (IK4**,IK3****)**

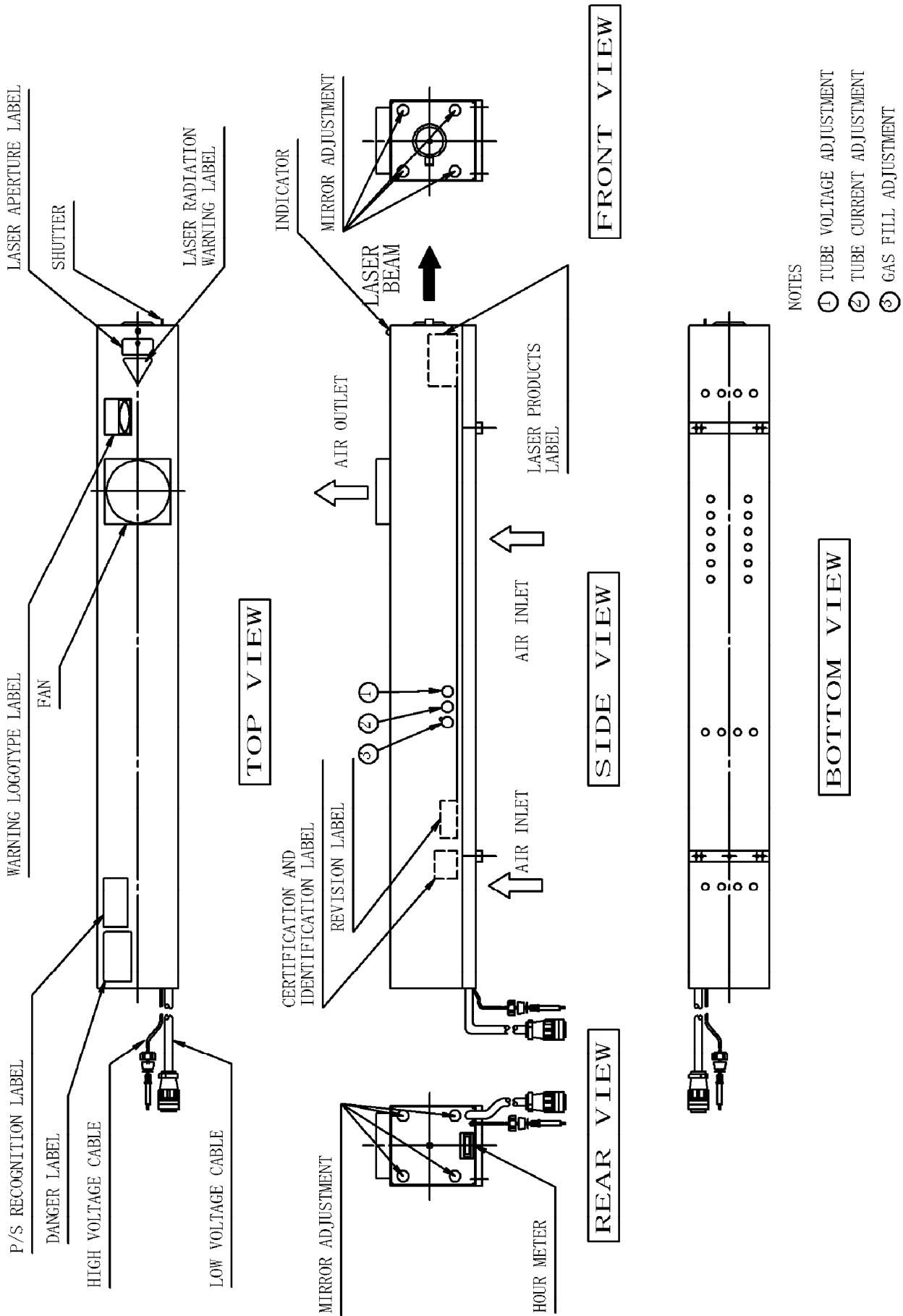

1-3-2 Laser Head (IK5****)

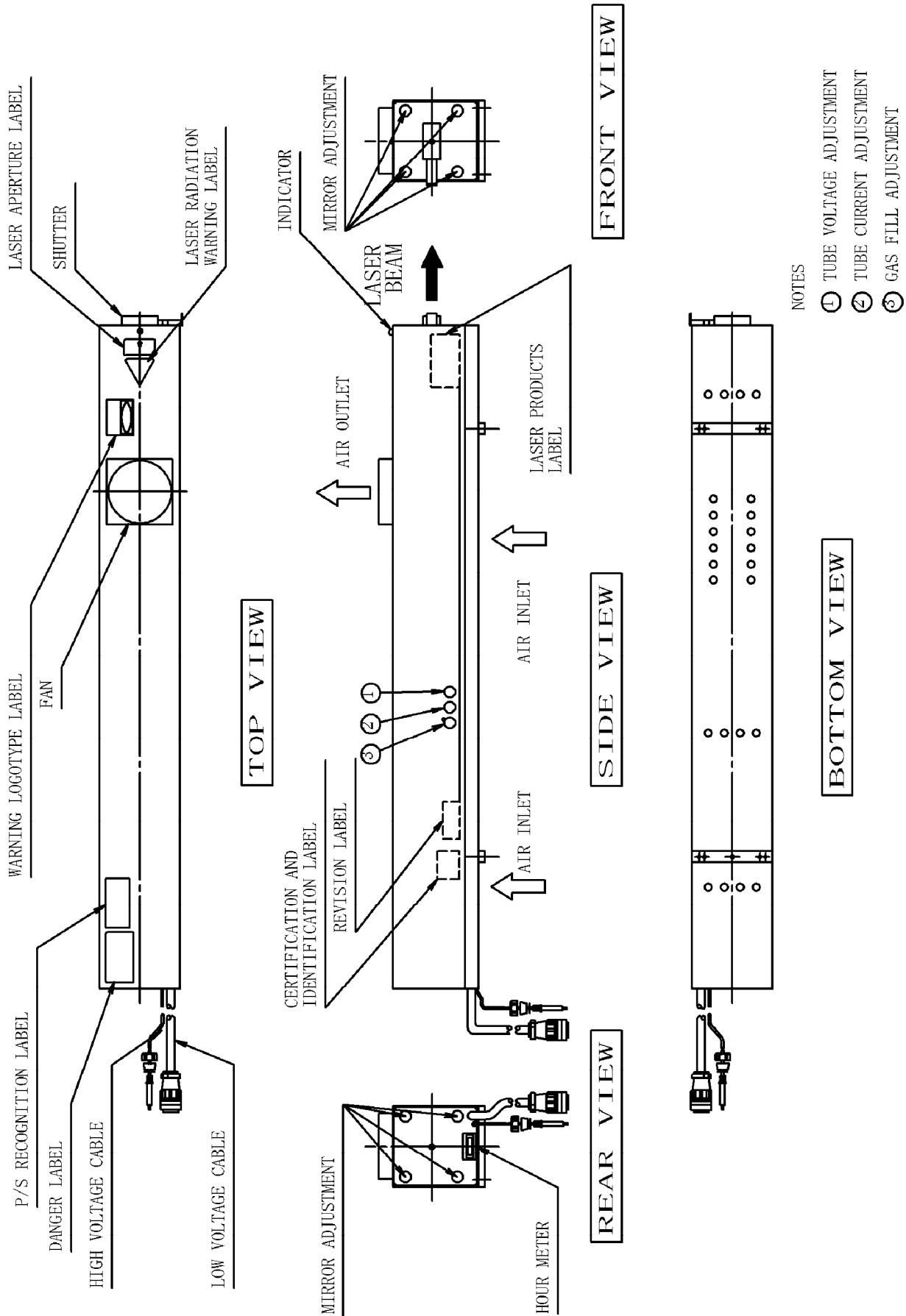

1-3-3 Power Supply (KR1801C)

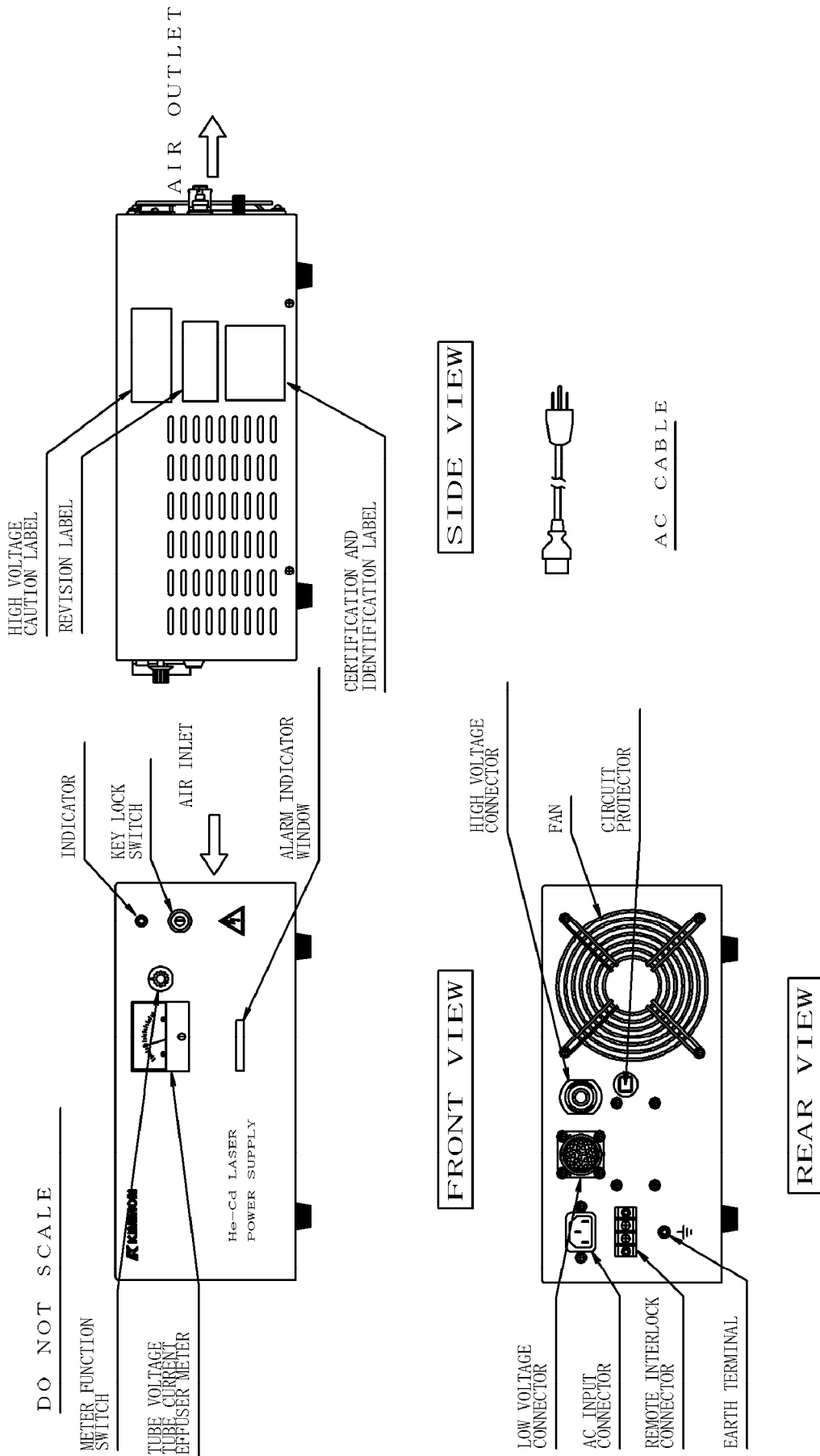

2. Laser Specifications

2-1 Specifications

I T E M	IK4301R-D	IK4401R-D	IK4601R-E	IK4101R-F
WAVELENGTH (nm)	441.6	441.6	441.6	441.6
INITIAL POWER (mW)	30	50	70	100
TRANSVERSE MODE	TEM00	TEM00	TEM00	TEM00
BEAM DIAMETER (1/e ²) (mm)	1.1	1.1	1.2	1.2
BEAM DIVERGENCE (mrad)	0.5	0.5	0.5	0.4
POLARIZATION	Linear	Linear	Linear	Linear
POLARIZATION RATIO	500:1	500:1	500:1	500:1
NOISE(P-P) (30k-2 MHz) (%)	10	10	10	15
NOISE(RMS) (30k-10 MHz) (%)	2	2	2	4
WARM UP TIME TO 90% POWER (min.)	20	20	20	20
BEAM POINTING STABILITY (μ rad)	± 25	± 25	± 25	± 25
POWER STABILITY (@25°C) (%)	± 2	± 2	± 2	± 2
POWER STABILITY (@10~40°C) (%)	20	20	20	20
LENGTH (mm)	850	850	1020	1200
WEIGHT (Kg)	16	16	17	19

I T E M	KR1801C	KR1801C	KR1801C	KR1801C
INPUT VOLTAGE (V)	AC117 \pm 10%	AC117 \pm 10%	AC117 \pm 10%	AC117 \pm 10%
INPUT CURRENT (A)	5.5	5.5	7	7.5
POWER CONSUMPTION (W)	500	500	610	660
FREQUENCY (Hz)	50/60	50/60	50/60	50/60
LINE CABLE LENGTH (m)	2	2	2	2
WEIGHT (Kg)	8	8	8	8

I T E M	IK4121R-G	IK4131I-G	IK4171I-G	IK3101R-D
WAVELENGTH (nm)	441.6	441.6	441.6	325.0
INITIAL POWER (mW)	125	150	180	10
TRANSVERSE MODE	TEM00	TEM00	TEM00	TEM00
BEAM DIAMETER (1/e ²) (mm)	1.2	1.2	1.4	1
BEAM DIVERGENCE (mrad)	0.4	0.4	0.5	0.5
POLARIZATION	Linear	Linear	Linear	Linear
POLARIZATION RATIO	500:1	500:1	500:1	500:1
NOISE(P-P) (30k-2 MHz) (%)	15	15	20	10
NOISE(RMS) (30k-10 MHz) (%)	4	4	5	2
WARM UP TIME TO 90% POWER (min.)	20	20	20	20
BEAM POINTING STABILITY (μ rad)	± 25	± 25	± 25	± 25
POWER STABILITY (@25°C) (%)	± 2	± 2	± 2	± 2
POWER STABILITY (@10~40°C) (%)	20	20	20	20
LENGTH (mm)	1420	1420	1420	850
WEIGHT (Kg)	23.5	23.5	23.5	16

I T E M	KR1801C	KR1801C	KR1801C	KR1801C
INPUT VOLTAGE (V)	AC117 \pm 10%	AC117 \pm 10%	AC117 \pm 10%	AC117 \pm 10%
INPUT CURRENT (A)	8	8	8	5.5
POWER CONSUMPTION (W)	720	720	720	500
FREQUENCY (Hz)	50/60	50/60	50/60	50/60
LINE CABLE LENGTH (m)	2	2	2	2
WEIGHT (Kg)	8	8	8	8

I T E M		IK3152R-D	IK3202R-D	IK3151R-E	IK3252R-E
WAVELENGTH	(nm)	325.0	325.0	325.0	325.0
INITIAL POWER	(mW)	15	25	15	30
TRANSVERSE MODE		Multi	Multi	TEM00	Multi
BEAM DIAMETER (1/e ²)	(mm)	1.6	1.6	1.2	1.8
BEAM DIVERGENCE	(mrad)	1	1	0.4	1
POLARIZATION		Linear	Linear	Linear	Linear
POLARIZATION RATIO		500:1	500:1	500:1	500:1
NOISE(P-P) (30k-2 MHz)	(%)	10	10	10	10
NOISE(RMS) (30k-10 MHz)	(%)	2	2	3	3
WARM UP TIME TO 90% POWER	(min.)	20	20	20	20
BEAM POINTING STABILITY	(μ rad)	± 25	± 25	± 25	± 25
POWER STABILITY (@25°C)	(%)	± 2	± 2	± 2	± 2
POWER STABILITY (@10~40°C)	(%)	20	20	20	20
LENGTH	(mm)	850	850	1020	1020
WEIGHT	(Kg)	16	16	17	17

I T E M		KR1801C	KR1801C	KR1801C	KR1801C
INPUT VOLTAGE	(V)	AC117 \pm 10%	AC117 \pm 10%	AC117 \pm 10%	AC117 \pm 10%
INPUT CURRENT	(A)	5.5	5.5	7	7
POWER CONSUMPTION	(W)	500	500	610	610
FREQUENCY	(Hz)	50/60	50/60	50/60	50/60
LINE CABLE LENGTH	(m)	2	2	2	2
WEIGHT	(Kg)	8	8	8	8

I T E M		IK3201R-F	IK3401R-F	IK3452R-F	IK3301R-G
WAVELENGTH	(nm)	325.0	325.0	325.0	325.0
INITIAL POWER	(mW)	20	40	45	30
TRANSVERSE MODE		TEM00	TEM00	Multi	TEM00
BEAM DIAMETER (1/e ²)	(mm)	1.2	1.2	1.8	1.2
BEAM DIVERGENCE	(mrad)	0.4	0.4	1	0.5
POLARIZATION		Linear	Linear	Linear	Linear
POLARIZATION RATIO		500:1	500:1	500:1	500:1
NOISE(P-P) (30k-2 MHz)	(%)	15	15	15	15
NOISE(RMS) (30k-10 MHz)	(%)	4	4	4	4
WARM UP TIME TO 90% POWER	(min.)	20	20	20	20
BEAM POINTING STABILITY	(μ rad)	± 25	± 25	± 25	± 25
POWER STABILITY (@25°C)	(%)	± 2	± 2	± 2	± 2
POWER STABILITY (@10~40°C)	(%)	20	20	20	20
LENGTH	(mm)	1200	1200	1200	1420
WEIGHT	(Kg)	19	19	19	23.5

I T E M		KR1801C	KR1801C	KR1801C	KR1801C
INPUT VOLTAGE	(V)	AC117 \pm 10%	AC117 \pm 10%	AC117 \pm 10%	AC117 \pm 10%
INPUT CURRENT	(A)	7.5	7.5	7.5	8
POWER CONSUMPTION	(W)	660	660	660	720
FREQUENCY	(Hz)	50/60	50/60	50/60	50/60
LINE CABLE LENGTH	(m)	2	2	2	2
WEIGHT	(Kg)	8	8	8	8

I T E M		IK3501R-G	IK3552R-G	IK3802R-G	IK3102R-G
WAVELENGTH	(nm)	325.0	325.0	325.0	325.0
INITIAL POWER	(mW)	50	55	80	100
TRANSVERSE MODE		TEM00	Multi	Multi	Multi
BEAM DIAMETER (1/e ²)	(mm)	1.2	1.8	1.8	1.8
BEAM DIVERGENCE	(mrad)	0.5	1	1	1
POLARIZATION		Linear	Linear	Linear	Linear
POLARIZATION RATIO		500:1	500:1	500:1	500:1
NOISE(P-P) (30k-2 MHz)	(%)	15	15	15	15
NOISE(RMS) (30k-10 MHz)	(%)	4	4	4	4
WARM UP TIME TO 90% POWER	(min.)	20	20	20	20
BEAM POINTING STABILITY	(μ rad)	± 25	± 25	± 25	± 25
POWER STABILITY (@25°C)	(%)	± 2	± 2	± 2	± 2
POWER STABILITY (@10~40°C)	(%)	20	20	20	20
LENGTH	(mm)	1420	1420	1420	1420
WEIGHT	(Kg)	23.5	23.5	23.5	23.5

I T E M		KR1801C	KR1801C	KR1801C	KR1801C
INPUT VOLTAGE	(V)	AC117 \pm 10%	AC117 \pm 10%	AC117 \pm 10%	AC117 \pm 10%
INPUT CURRENT	(A)	8	8	8	8
POWER CONSUMPTION	(W)	720	720	720	720
FREQUENCY	(Hz)	50/60	50/60	50/60	50/60
LINE CABLE LENGTH	(m)	2	2	2	2
WEIGHT	(Kg)	8	8	8	8

I T E M		IK5351R-D	IK5352R-D	IK5451R-E	IK5452R-E
WAVELENGTH	(nm)	325.0/441.6	325.0/441.6	325.0/441.6	325.0/441.6
INITIAL POWER	(mW)	5/35	10/50	10/50	15/65
TRANSVERSE MODE		TEM00	Multi	TEM00	Multi
BEAM DIAMETER (1/e ²)	(mm)	0.9/1	1.3	1/1.1	1.3
BEAM DIVERGENCE	(mrad)	0.5	1	0.5	1
POLARIZATION		Linear	Linear	Linear	Linear
POLARIZATION RATIO		500:1	500:1	500:1	500:1
NOISE(P-P) (30k-2 MHz)	(%)	10	10	10	10
NOISE(RMS) (30k-10 MHz)	(%)	2	2	3/2	3/2
WARM UP TIME TO 90% POWER	(min.)	20	20	20	20
BEAM POINTING STABILITY	(μ rad)	± 25	± 25	± 25	± 25
POWER STABILITY (@25°C)	(%)	± 2	± 2	± 2	± 2
POWER STABILITY (@10~40°C)	(%)	20	20	20	20
LENGTH	(mm)	850	850	1020	1020
WEIGHT	(Kg)	16	16	17	17

I T E M		KR1801C	KR1801C	KR1801C	KR1801C
INPUT VOLTAGE	(V)	AC117 \pm 10%	AC117 \pm 10%	AC117 \pm 10%	AC117 \pm 10%
INPUT CURRENT	(A)	5.5	5.5	7	7
POWER CONSUMPTION	(W)	500	500	610	610
FREQUENCY	(Hz)	50/60	50/60	50/60	50/60
LINE CABLE LENGTH	(m)	2	2	2	2
WEIGHT	(Kg)	8	8	8	8

I T E M		IK5551R-F	IK5552R-F	IK5651R-G	IK5652R-G
WAVELENGTH	(nm)	325.0/441.6	325.0/441.6	325.0/441.6	325.0/441.6
INITIAL POWER	(mW)	15/60	25/100	20/80	30/120
TRANSVERSE MODE		TEM00	Multi	TEM00	Multi
BEAM DIAMETER (1/e ²)	(mm)	1.1/1.2	1.5	1.2	1.8
BEAM DIVERGENCE	(mrad)	0.5	1	0.5	1
POLARIZATION		Linear	Linear	Linear	Linear
POLARIZATION RATIO		500:1	500:1	500:1	500:1
NOISE(P-P) (30k-2 MHz)	(%)	15	15	15	15
NOISE(RMS) (30k-10 MHz)	(%)	4	4	4	4
WARM UP TIME TO 90% POWER	(min.)	20	20	20	20
BEAM POINTING STABILITY	(μ rad)	± 25	± 25	± 25	± 25
POWER STABILITY (@25°C)	(%)	± 2	± 2	± 2	± 2
POWER STABILITY (@10~40°C)	(%)	20	20	20	20
LENGTH	(mm)	1200	1200	1420	1420
WEIGHT	(Kg)	19	19	23.5	23.5

I T E M		KR1801C	KR1801C	KR1801C	KR1801C
INPUT VOLTAGE	(V)	AC117 \pm 10%	AC117 \pm 10%	AC117 \pm 10%	AC117 \pm 10%
INPUT CURRENT	(A)	7.5	7.5	8	8
POWER CONSUMPTION	(W)	660	660	720	720
FREQUENCY	(Hz)	50/60	50/60	50/60	50/60
LINE CABLE LENGTH	(m)	2	2	2	2
WEIGHT	(Kg)	8	8	8	8

I T E M		IK5751I-G	IK5752I-G
WAVELENGTH	(nm)	325.0/441.6	325.0/441.6
INITIAL POWER	(mW)	30/110	40/150
TRANSVERSE MODE		TEM00	Multi
BEAM DIAMETER (1/e ²)	(mm)	1.2	1.8
BEAM DIVERGENCE	(mrad)	0.5	1
POLARIZATION		Linear	Linear
POLARIZATION RATIO		500:1	500:1
NOISE(P-P) (30k-2 MHz)	(%)	15/20	15/20
NOISE(RMS) (30k-10 MHz)	(%)	4	4
WARM UP TIME TO 90% POWER	(min.)	20	20
BEAM POINTING STABILITY	(μ rad)	± 25	± 25
POWER STABILITY (@25°C)	(%)	± 2	± 2
POWER STABILITY (@10~40°C)	(%)	20	20
LENGTH	(mm)	1420	1420
WEIGHT	(Kg)	23.5	23.5

I T E M		KR1801C	KR1801C
INPUT VOLTAGE	(V)	AC117 \pm 10%	AC117 \pm 10%
INPUT CURRENT	(A)	8	8
POWER CONSUMPTION	(W)	720	720
FREQUENCY	(Hz)	50/60	50/60
LINE CABLE LENGTH	(m)	2	2
WEIGHT	(Kg)	8	8

Optional input voltage : AC100/110/220/230/240V

The beam diameter is measured at 100mm from output mirror.

Laser system environmental conditions (No condensation).

Operation : Temperature 10°C~40°C : Relative Humidity 90% or Less

Non Operation : Temperature -10°C~50°C : Relative Humidity 90% or Less

The mechanical parts of this device are expected to have a durability in 7 years.

2-2 Dimensions

2-2-1 Laser Head (IK4****,IK3****)

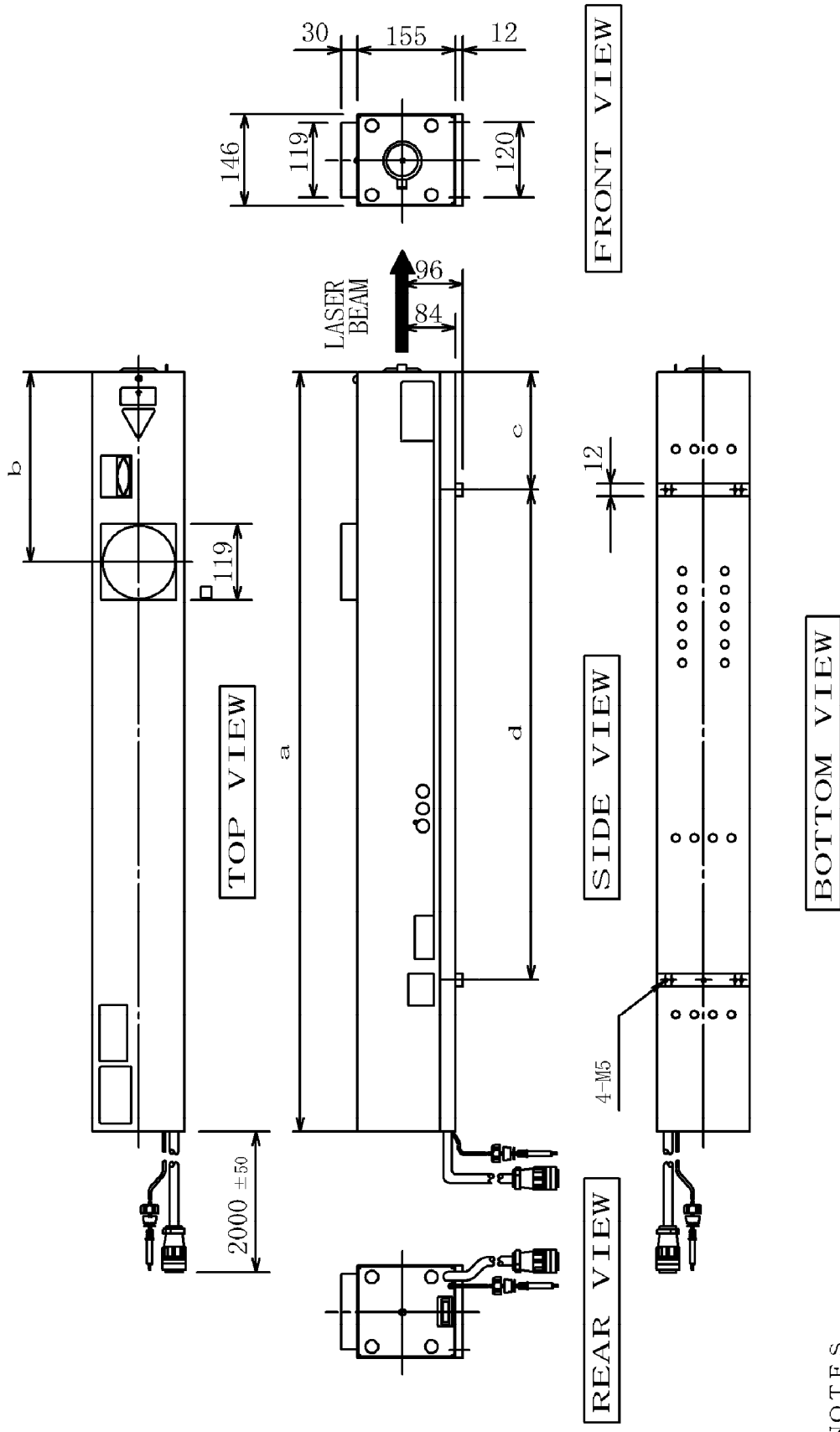

NOTES

±2mm TOLERANCE APPLIES TO ALL DIMENSIONS UNLESS OTHERWISE SPECIFIED.
UNIT : mm

	a	b	c	d
IK****R-D	850	380	128	605
IK****R-E	1020	300	128	775
IK****R-F	1200	300	353	440
IK****R-G	1420	461	353	660

2-2-2 Laser Head (IK5****)

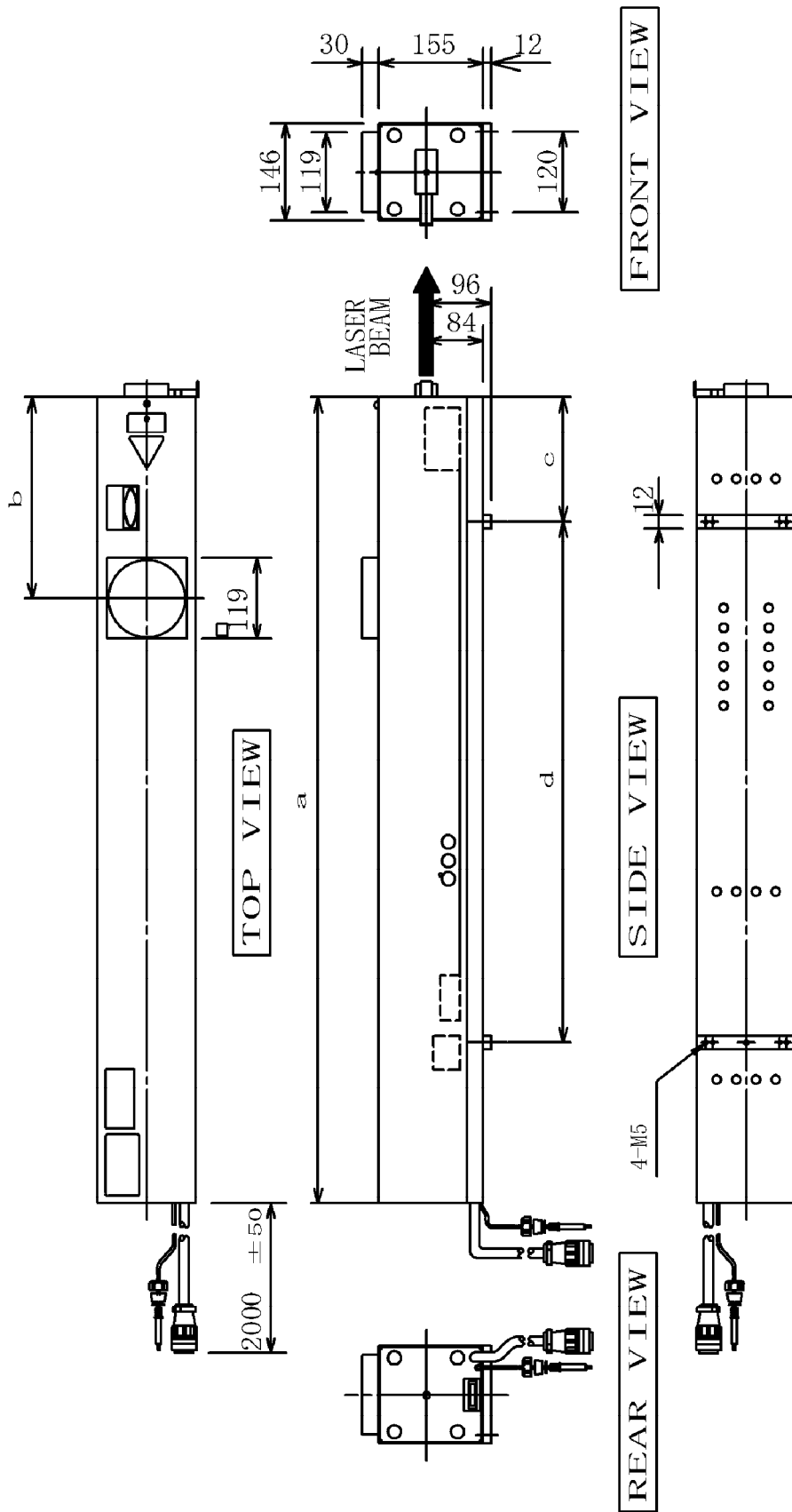

NOTES

	a	b	c	d
IK****R-D	850	380	128	605
IK****R-E	1020	300	128	775
IK****R-F	1200	300	353	440
IK****R-G	1420	461	353	660

±2mm TOLERANCE APPLIES TO ALL DIMENSIONS UNLESS OTHERWISE SPECIFIED.

UNIT : mm

2-2-3 Wavelength Selector

The wavelength can be chosen by setting the position of the shutter as below;

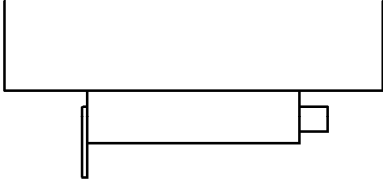
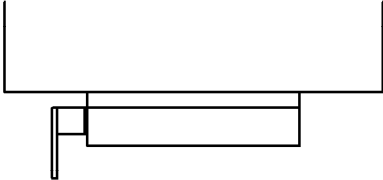
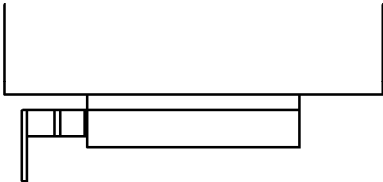
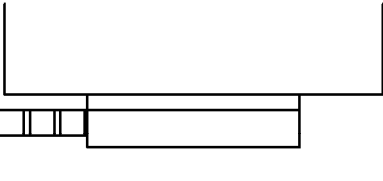
WAVELENGTH	SHUTTER POSITION
OFF	 A schematic diagram of a shutter mechanism. It consists of a horizontal bar with a vertical stem on the left and a small rectangular protrusion on the right. The bar is positioned below a larger rectangular frame.
441.6nm ONLY	 A schematic diagram of a shutter mechanism. It consists of a horizontal bar with a vertical stem on the left and a rectangular protrusion on the right. The bar is positioned below a larger rectangular frame.
325.0nm ONLY	 A schematic diagram of a shutter mechanism. It consists of a horizontal bar with a vertical stem on the left and a rectangular protrusion on the right. The bar is positioned below a larger rectangular frame.
325.0nm AND 441.6nm	 A schematic diagram of a shutter mechanism. It consists of a horizontal bar with a vertical stem on the left and a rectangular protrusion on the right. The bar is positioned below a larger rectangular frame.

2-2-4 Power Supply (KR1801C)

(ALLOWANCE DIMENSIONS OF CONNECTORS)

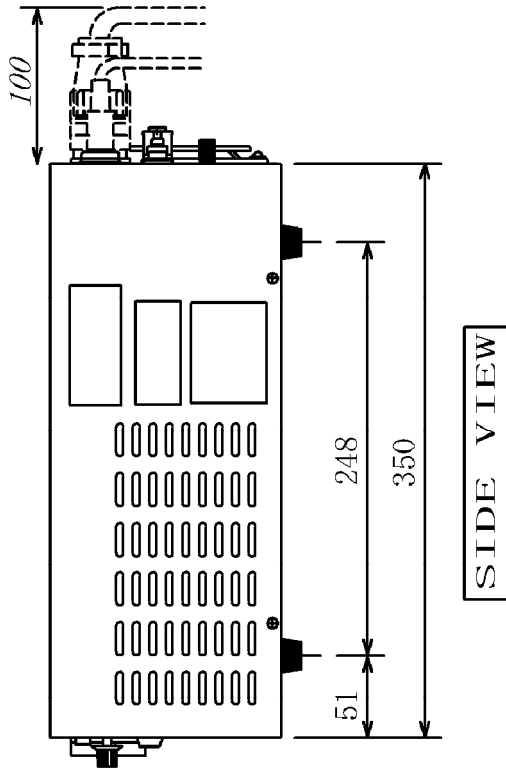

AC CABLE: 2000±20

±2mm TOLERANCE APPLIES TO ALL DIMENSIONS UNLESS OTHERWISE SPECIFIED.

UNIT : mm

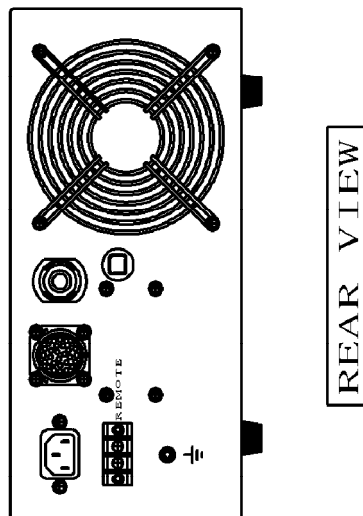
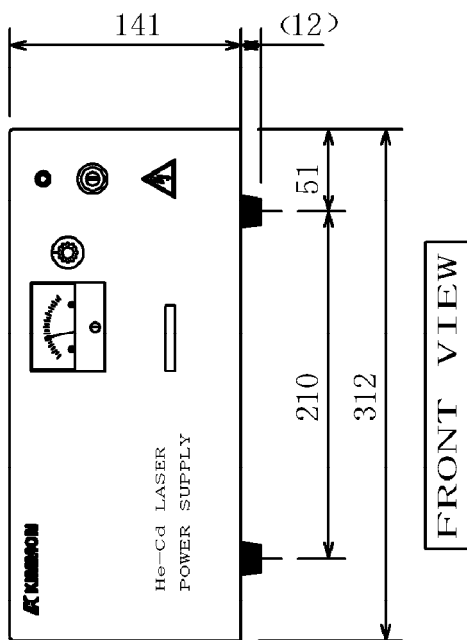

3. Laser Block Diagram

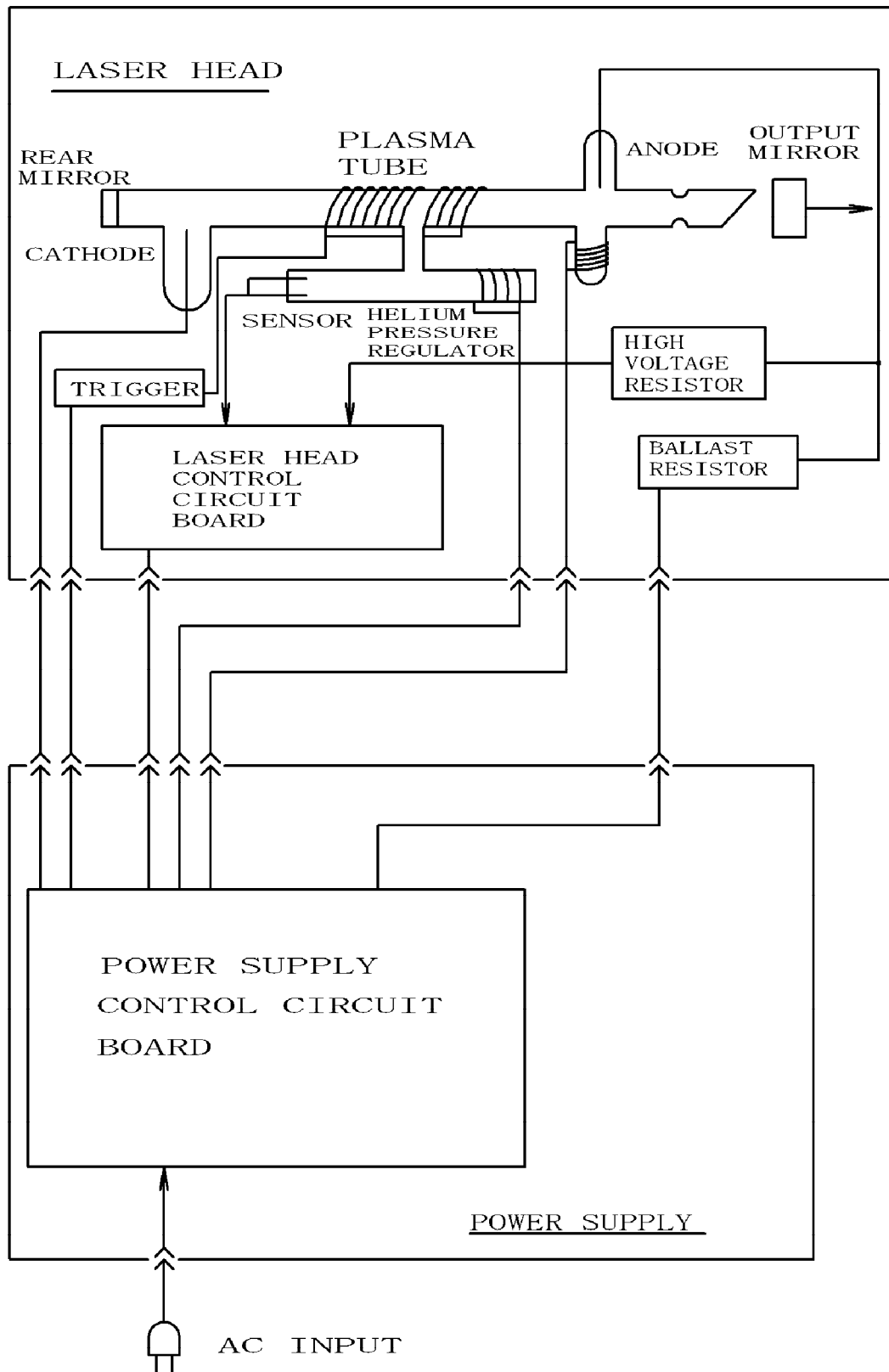

4. Safety Recommendations & Safety Hazard Warning

4-1 General Instruction

- a) **Remote interlock connector**
Use this connector to interlock with door switch or emergency switch.
- b) **Key lock switch**
Designate a person who safekeeps the key while the laser is not in use.
- c) **Beam shutter or attenuator**
Close the shutter while the laser system is not in use.
- d) **Warning sign**
Post a warning sign near the laser area.
- e) **Warning labels**
Follow the instructions on warning labels.
- f) **Beam target**
Set up a target for the beam to prevent the beam from going out of the laser area designated for laser system and to prevent unwanted reflections. A folded metal sheet with black paint is suggested.
- g) **Protective glasses**
Always wear a protective glasses which is designed to cut out the laser radiation at the wavelength of your laser system.

4-2 High Voltage and Temperature Hazard

A high voltage (up to 4kV) is supplied to the electrical circuits of laser head and power supply. Do not remove protective housing of laser head or power supply in any event. Whenever replacement of the laser head or power supply is necessary, first shut down the system by turning the key lock switch counter-clockwise and wait for 10 minutes before unplugging cables. During operation and even after shut down of the laser system, the temperature of the capillary tube exceeds 200°C. Never open the protective housing to avoid burning.

4-3 Handling and Installation

- a) **Laser system is a precision equipment. Do not install it where it is hot, humid, or dusty. No direct exposure to the sun rays is allowed.**
- b) **Refrain from use where it is quickly heated up or cooled, or where it has direct flow of cool or warm air.**
- c) **Avoid shock or vibration to the system. Shock and vibration may impair the optical system and result in insufficient laser power or tube damage.**
- d) **Place the system at level location.**
- e) **Do not move the system until 10 minutes after shut down.**
- f) **When moving the laser system, have 2 persons at each end of the laser head to keep the system level and to avoid shock to the system.**

4-4 Abnormal Conditions

If abnormal conditions are observed, shut off the laser system immediately and refer to Chapter 6.

5. Operating Instruction

5-1 Inspection Requirement Upon Receipt

The laser head and power supply are separately packed carefully to stand shocks during transportation. Upon receipt of the delivery, check the quantity of units and parts on the packing list and inspect if there is any damage on them.

Should you find any discrepancy or damage, please contact nearby sales representative or KIMMON headquarters in Tokyo.

5-2 Packing Contents

Confirm items included and quantity included.

Check

- | | |
|--|--------------------------------|
| a) Laser head(with high voltage and low voltage cable) | 1 set <input type="checkbox"/> |
| b) Power supply(with key lock switch) | 1 set <input type="checkbox"/> |
| c) Power cable | 1 set <input type="checkbox"/> |
| d) Test data | 1 set <input type="checkbox"/> |
| e) Instruction manual | 1 set <input type="checkbox"/> |

5-3 Installation

After completing the inspection upon receipt of your laser, install the laser head in such a way that the laser beam is not at your eyes level. Also confirm the key lock switch is at "OFF" position.

5-4 Cables

- a) Connect the high voltage cable (1P) to the high voltage connector as below.
 - a-1) Insert the high voltage plug tightly.
 - a-2) Insert the inner rubber and confirm that the metal washer is fitted in the front of inner rubber.
 - a-3) Tighten the screw cap.
 - a-4) To disconnect the high voltage connector, reverse the above procedure.

Note : Do NOT pull the high voltage cable to disconnect.

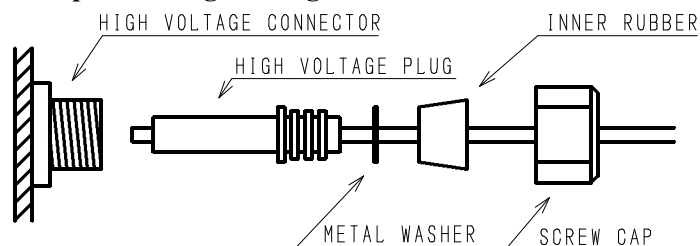

- b) Connect the low voltage cable (28P) to the low voltage connector.
- c) The power supply 3pin plug is equipped with an earth terminal. When the third terminal of the receptacle is grounded, the plugging automatically grounds the power supply. If your receptacle is 2pin type, be sure to ground the earth terminal of the plug.
- d) Connect the remote interlock circuit.
 - * Disconnect the short wire of the remote interlock terminal (2P) of the power supply.
 - * Connect emergency switch or door switch (more than 125V, 10A) to the remote interlock terminal (2P) of the power supply.(Use switches where the circuit will become open in case of emergency.)

Sample Connection

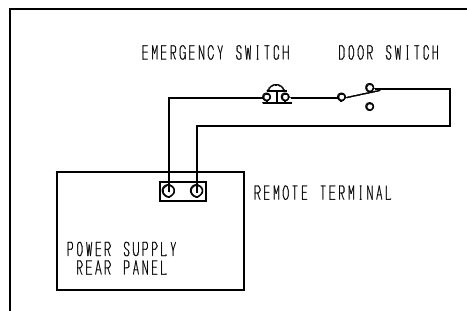

e) Connect the AC117V power cable to receptacle on the power supply's rear panel.

5-5 Operation

5-5-1 Actuation Sequence (Normal Actuation Sequence)

Key lock switch turned ON.



Indicator lamp ON.



Current supplied to cathode heater in the laser tube.



High voltage (4kV) impressed to the anode in the laser tube and starts discharge.
Trigger voltage(15kV) ON.



Tube voltage is stabilized around 2.0-4.3kV, whereas tube current fluctuates between 70 and 95 mA.

5-5-2 Startup

Turn on the key lock switch on the front panel. (The indicator illuminates, and the fan starts up.) Then the system will automatically move into a steady operation condition. After about 1.5 minutes, the discharge begin to start. Further after a few minutes, the laser beam emits. The laser beam will be stable after 30~60 minutes.

5-5-3 Shutdown

Turn off the key lock switch. (The indicator turns off, and the fan stops.) Then the laser beam stops.

Notice : Frequent startup and shutdown may cause damage to the laser tube.

(a) Do not shutdown the laser system within 30 minutes after the latest startup.

(b) After shutting the laser system off, wait for 30 minutes before restart.

5-6 Status Indicators

The laser operating conditions can be monitored by the LEDs in the window.

Alarm Indicator Window

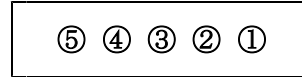

Each LED monitors the followings:

LED5 Green	LED4 Red	LED3 Yellow	LED2 Orange	LED1 Green	Status & Alarm Contents
○	×	×	×	○	Normal Operation
○	×	×	×	×	Remote OFF
×	×	○	×	×	Tube Current Failure
×	×	×	○	×	External Interlock Open
×	flash 1	×	×	×	Tube Voltage Failure
×	flash 2	×	×	×	+24V Supply Failure
×	flash 3	×	×	×	Cathode Failure
×	flash 4	×	×	×	Temperature Failure
					Input Voltage Failure

Remark: "flash □" means "flash □ time(s) in a certain interval"

6. Trouble Shooting

6-1 Diagnostic Flow Chart (No Power Status)

Status	Check Points	Measures
<p>Turn on key lock switch.</p> <p>Is the power ON?</p>	<p>① Check if AC117V is supplied to wall receptacles.</p> <p>② Check ambient temperature.</p>	<p>① Use a receptacle where AC117V is supplied.</p> <p>② Set the temperature between 10~40°C.</p>

6-2 Diagnostic Flow Chart (Emission Indicator "OFF" Status)

Status	Check Points	Measures
<p>Turn on key lock switch.</p> <p>System does not start. Indicator lamp is off.</p>	<p>① Is thermal alarm ON?</p> <p>② Is the fan operating?</p>	<p>Also refer to Section 6-7.</p>
<p>Is AC117V supplied?</p>	<p>① Check if AC117V is supplied to wall receptacles.</p> <p>② Check connection of power supply cables and the receptacles.</p>	<p>① Use a receptacle where AC117V is supplied.</p> <p>② Connect cables properly.</p>
<p>Is remote control connector shorted?</p>	<p>A terminal is provided on rear panel of power supply. Check if the terminal is shorted. (or check if the switch for remote control is on when it is used as remote control connector.)</p>	<p>Short it. (or turn on the remote control connector switch.)</p>
<p>Is circuit protector on?</p>	<p>Check if the circuit protector is tripped.</p>	<p>Pushing the button resumes operation. However, first check the followings:</p> <p>① Supplied voltage is AC117V</p> <p>② Ambient temperature does not exceed 40°C.</p> <p>If it is tripped again even after the reset procedure, contact us immediately.</p>
<p>Contact us immediately.</p>		

If you do not see improvements after the suggested measures, please contact the nearest representative or KIMMON immediately.

6-3 Diagnostic Flow Chart (Emission Indicator "ON" Status)

Status	Check points	Measures
Turn on key lock switch.		
Indicator lights ON?		
Have 1 min. passed? NO		Please wait for 1 minute.
YES		
Is the shutter open? NO	Check that shutter is open.	Open the shutter.
YES		
Have 20 min. passed? NO	The metal vapor laser needs 10 to 20 minutes to get stable.	
YES		
NO		
Is AC117V supplied properly? NO	① Check if AC117V is supplied to wall receptacle. ② Check connection of power cable and the receptacle.	① Use a receptacle of AC117V. ② Connect cables properly.
YES		
Is the tube discharged? NO	Look through fan port of laser head, and check glow inside.	If no glow, contact us.
YES		
Is the sound heard? YES	Hear the sound of spark?	If such sound is heard, contact us. (may be a trigger leak.)
NO		
Is the tube voltage correct? NO	Compare the voltage with those listed in test run record.	Contact us if the reading is far from value given in final inspection report.
YES		
Is the effuser scale correct? NO	Read the meter. (0.5 ± 0.2)	If the pointer does not come down from a peak, which means that cadmium is exhausted and the laser tube ceased its function. (Approx. 0.8)
YES		
Contact us immediately.		

If you do not see improvements after the suggested measures, please contact the nearest representative or KIMMON immediately.

6-4 Diagnostic Flow Chart (Decreased Laser Output Power)

Status	Check points	Measures
<div style="border: 1px solid black; padding: 5px; text-align: center;">Laser output is decreased.</div> <div style="border: 1px solid black; padding: 5px; text-align: center;">Mirror alignment</div> <div style="text-align: center;">NO</div> <div style="text-align: center;">YES</div>	Check if mirrors are aligned.	Please refer to Section 7-1.
<div style="border: 1px solid black; padding: 5px; text-align: center;">Fan in the laser head operating</div> <div style="text-align: center;">NO</div> <div style="text-align: center;">YES</div>	Check if fan in the laser head is rotating.	If not, contact us immediately.
<div style="border: 1px solid black; padding: 5px; text-align: center;">Head ventilation ports</div> <div style="text-align: center;">NO</div> <div style="text-align: center;">YES</div>	Check if any interference at inlet and outlet ventilation ports. A poor ventilation may cause misalignment of mirror.	Keep enough room at both inlet and outlet ventilation ports.
<div style="border: 1px solid black; padding: 5px; text-align: center;">Tube voltage setting</div> <div style="text-align: center;">NO</div> <div style="text-align: center;">YES</div>	Confirm if the tube voltage is same as the value given in the final inspection report.	① Please refer to Section 7-2. ② After 5000 hours usage, it may be the laser tube's life end.
<div style="border: 1px solid black; padding: 5px; text-align: center;">Tube current setting</div> <div style="text-align: center;">NO</div> <div style="text-align: center;">YES</div>	Confirm if the tube current is same as the value given in the final inspection report.	Please refer to Section 7-3.
<div style="border: 1px solid black; padding: 5px; text-align: center;">Ambient temperature</div> <div style="text-align: center;">NO</div> <div style="text-align: center;">YES</div>	Check if ambient temperature is between 10°C and 40°C.	Use under the specified temperature range.
<div style="border: 1px solid black; padding: 5px; text-align: center;">Contact us immediately.</div>		

If you do not see improvements after the suggested measures, please contact the nearest representative or KIMMON immediately.

6-5 Diagnostic Flow Chart (Increased Noise Level)

Status	Check points	Measures
<div style="border: 1px solid black; padding: 5px; text-align: center;">Laser noise is increased.</div> <div style="text-align: center;">YES</div> <div style="border: 1px solid black; padding: 5px; text-align: center;">Tube voltage setting</div> <div style="text-align: center;">NO</div> <div style="text-align: center;">YES</div> <div style="border: 1px solid black; padding: 5px; text-align: center;">Tube current setting</div> <div style="text-align: center;">NO</div> <div style="text-align: center;">YES</div> <div style="border: 1px solid black; padding: 5px; text-align: center;">Ambient temperature</div> <div style="text-align: center;">NO</div> <div style="text-align: center;">YES</div> <div style="border: 1px solid black; padding: 5px; text-align: center;">Contact us immediately.</div>	<p>Confirm if the tube voltage is same as the value given in the final inspection report.</p> <hr style="border-top: 1px dashed black;"/> <p>Confirm if the tube current is same as the value given in the final inspection report.</p> <hr style="border-top: 1px dashed black;"/> <p>Check if ambient temperature between 10°C and 40°C.</p>	<p>Please refer to Section 7-2.</p> <hr style="border-top: 1px dashed black;"/> <p>Please refer to Section 7-3.</p> <hr style="border-top: 1px dashed black;"/> <p>Use under the specified temperature range.</p>

If you do not see improvements after the suggested measures, please contact the nearest representative or KIMMON immediately.

6-6 Diagnostic Flow Chart (Unstable Laser Output Power)

Status	Check points	Measures
Laser output power fluctuates.		
Fluctuation with less than 1 min. periodicity	<p>YES</p> <p>① Check the effuser meter and see if pointer stays still or fluctuates within 0.1 scale. More than 0.1 scale fluctuation is directly reflected to tube voltage.</p> <p>② Turn rotary switch to the position of tube current, and check pointer behavior.</p>	<p>① Keep running for 1 hour and check again. If still fluctuates more than 0.1 scale, refer to Section 7-2 for adjustment.</p> <p>② If not improved, refer to Section 7-3 for adjustment.</p>
Fluctuation with more than 1 hour periodicity	<p>NO</p> <p>① Check if ambient temperature fluctuation is more than 10°C.</p> <p>② Check if air from air conditioner directly hit the laser head, or check any other factors which might be affecting the ambient temperature.</p>	<p>Keep from use under the condition where ambient temperature considerably fluctuates.</p>
Contact us immediately.		

If you do not see improvements after the suggested measures, please contact the nearest representative or KIMMON immediately.

6-7 Diagnostic Flow Chart (Other Status)

Status	Check points	Measures
Interlock alarm ON	Check if there are any interference at inlet and outlet ventilation ports.	Leave enough room for ventilation ports.
Other alarms ON	Take note of which alarm is on.	Contact us immediately.

If you do not see improvements after the suggested measures, please contact the nearest representative or KIMMON immediately.

7. Maintenance and Adjustment

7-1 Mirror Alignment

Mirrors misalignment is one of the most common reasons for laser power reduction. The misalignment is caused by external factors such as ambient temperature change. To recover the laser power, re-align the mirror to optimum condition.

Tools : Protective eye glasses
Power monitor
10mm hexagonal box driver for M6 nuts

Preparation

- (a) Remove the rubber-cap at the mirror adjusting-screw hole.
- (b) Turn on the laser system for 20 minutes to allow temperature of oscillator to be stable.
- (c) Check if the tube voltage and current are set at an optimum points.
(Refer to the final inspection report.)
If the tube voltage and current are off, first adjust the voltage and current before attempting mirror adjustment.

Adjustment

- (a) Monitor the laser power with the power monitor.
- (b) An adjusting screw is provided on the rear panel of the laser head to move the mirror in vertical direction. Turn the screw with the hexagonal box driver clockwise or counter-clockwise very slightly watching the power to reach the maximum power.
- (c) For mirror adjustment in horizontal direction, another screw is provided. Turn and stop the screw in the same manner as the adjustment in the vertical direction.
- (d) Repeat the steps (b) and (c) for a fine adjustment.

Cautions

When turning the screws, turn the screws very slightly at one time and repeat the action. If screws are turned too much at one time, the oscillation may stop. Should it stop, just turn the screw back slowly; and the oscillation will be resumed. If there is a difficulty in getting access to the screws on the front panel, you may alternatively adjust it with the screws on the rear panel.

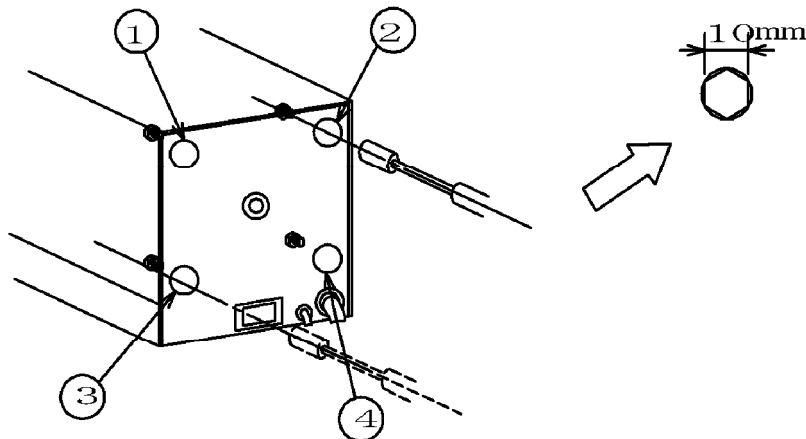

7-2 Tube Voltage

When you see the laser power is decreased or unstable or increasing in noise level, it may be recovered by adjusting the tube voltage.

Tools : Power monitor

Oscilloscope (for simplified noise check)

Slotted screwdriver

Protective glasses

Preparation

- (a) Turn on the laser system for 20 minutes before starting the adjustment.
- (b) Switch "CURRENT/VOLT/EFFUSER" to Volt side on the power supply's front panel. Make sure to monitor the power and the noise level.

Adjustment

First, turn the knob only by 5 degrees, and monitor the laser with the voltmeter (TUBE VOLT), power monitor, and oscilloscope. Wait for at least 5 minutes before turning the knob for another 5 degrees. Repeat these steps to look for an optimum laser power and noise. When coming close to an optimum point, turn the knob just a little for a fine adjustment.

Keep the voltage adjustment range within $\pm 100V$ of the value given in the final inspection report.

- (a) If the knob is turned clockwise, the tube voltage is increased.
(The effuser current dip briefly before the tube voltage increases.)
- (b) If turned counter-clockwise, the tube voltage is decreased.
(The effuser current increases briefly before the tube voltage decreases.)

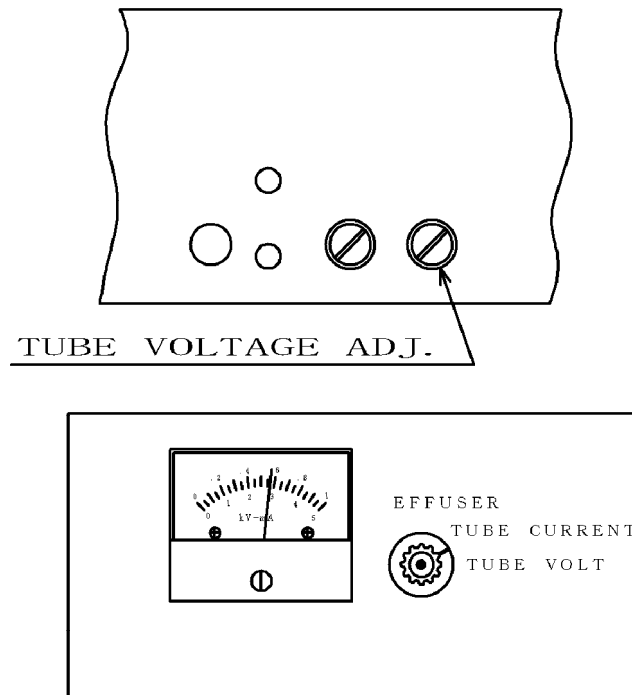

7-3 Tube Current

When you see the laser power is decreased or unstable or increasing in noise level, it may be recovered by adjusting the tube current.

Only adjust tube current after adjusting tube voltage.

Tools : Power monitor

Oscilloscope (for simplified noise check)

Protective glasses

Preparation

- (a) Turn on the laser system for 20 minutes before starting the adjustment.
- (b) Switch "CURRENT/VOLT/EFFUSER" to Current side on the power supply's front panel. Make sure to monitor the power and the noise level.
- (c) Attempt the tube voltage adjustment before the current adjustment.

Adjustment

First, turn the knob to change the current for up to 5mA and monitor the laser with the voltmeter (TUBE CURRENT), power monitor and oscilloscope. Wait for at least 10 minutes before turning the knob for another 5mA. (MAX. 100mA) Repeat these steps to look for an optimum laser power and noise.

When it comes close to an optimum, turn the knob just a little for a fine adjustment.

- (a) If the knob is turned counter-clockwise, the tube current is decreased.
- (b) If turned clockwise, the tube current is increased.

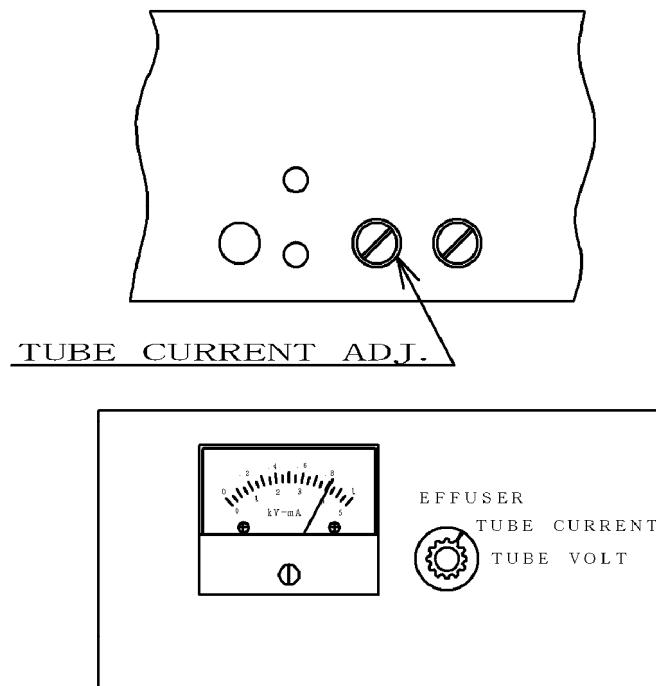

7-4 Helium Gas Pressure Adjustment

The Helium gas pressure can be adjusted by the potentiometer which is provided on the side of the laser head.

Tools : Power monitor
Voltmeter(Digital type)
Slotted screwdriver
Protective glasses

Preparation

- This adjustment must be started 30 minutes after the system is powered.
- When making adjustment , always monitor the laser power.
- Since a change will not be observed immediately after an adjustment, wait for 1 day before another adjustment.

Adjustment

- When making adjustment , always monitor the laser power.
- Connect the voltmeter to Gas Sig Check Point, and select the DC range.
- If the Gas Fill LED is flickering when the voltage is between $-5\text{mV} \sim -15\text{mV}$, it is normal.
- To raise the pressure , raise the voltage.(Turn the POT clockwise.)
To lower it , turn counter-clockwise.

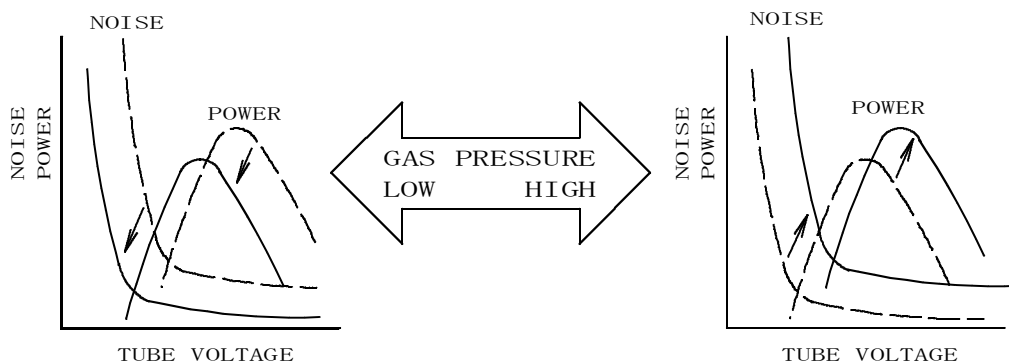
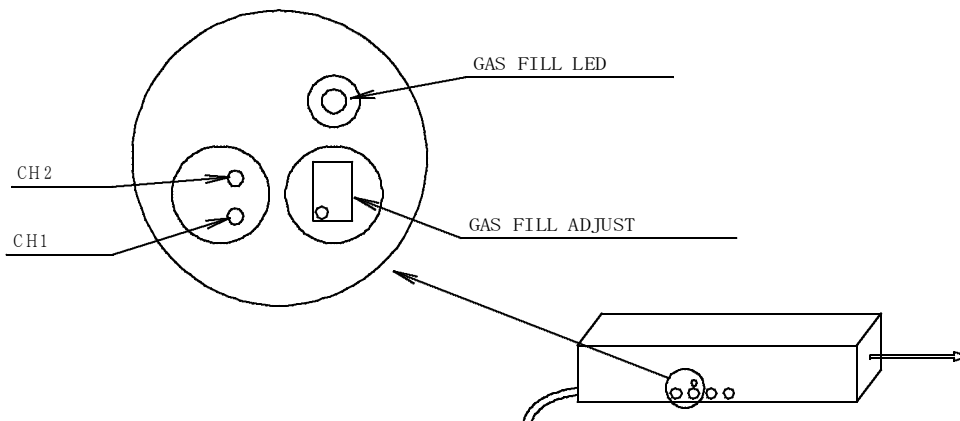

7-5 Laser System Storage Period

The tube voltage (cadmium vapor pressure), tube current, and helium gas pressure all contribute to the laser power and noise level. The helium gas pressure changes gradually during storage. For storage over a period of 2 months, it is recommended that the laser system be run for 48 hours at least once every 2 months to maintain the helium gas pressure at optimum level.

8. Laser System Disposal

The heavy metal, cadmium, is sealed in the laser tube. Such heavy metal must be disposed according to the government's regulations. Contact your government or its agencies for further details, or contact KIMMON for disposal for fee under consignment basis.

9. Package for Tube Refurbishing and Repairing

When you ship your laser system back for tube refurbishing and repairing, use the package provided when the laser system was delivered to you.

10. Where to Contact Us

**TOKYO HEAD OFFICE
1-53-2 ITABASHI, ITABASHI-KU, TOKYO, 173-0004 JAPAN
PHONE 81-3-5248-4820 FAX 81-3-5248-0021**